

















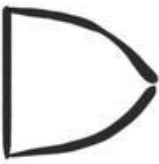





























Picasso, along with his colour portraits, drew these simple line drawings. Have a go at creating your own, use your favourite animal as your inspiration.



Draw the missing half of the face. This is a self portrait Picasso drew of himself in his 90's.

Roll a Picasso

	Roll 1	Roll 2	Roll 3	Roll 4	Roll 5	Roll 6	Roll 7
	Head Shape	1st eye	2nd eye	Nose	Mouth	1st ear	2nd ear
							
							
							
							
							
							

Create a self portrait using the dice you've made. Follow the instructions on this table.

Artist of the week

Pablo Picasso

Pablo Ruiz Picasso was a Spanish painter, sculptor, printmaker, ceramicist and theatre designer who spent most of his adult life in France.

Born: 25 October 1881, [Málaga, Spain](#)

Died: 8 April 1973, [Mougins, France](#)



Periods



Cubism



Surrealism



Expressionism



Post-Impressionism



Neoclassicism



Synthetic cubism



Naïve art



Modernism



Realism



Impressionism



Symbolism

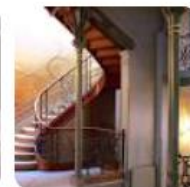

Art Nouveau



Picasso's Blue Period



Picasso's Rose Period



Picasso's African Period



Modern art



Pointillism



Analytical Cubism

Picasso had 25 names.

Picasso was accused of stealing the Mona Lisa.

Picasso has had more paintings stolen than any other artist.

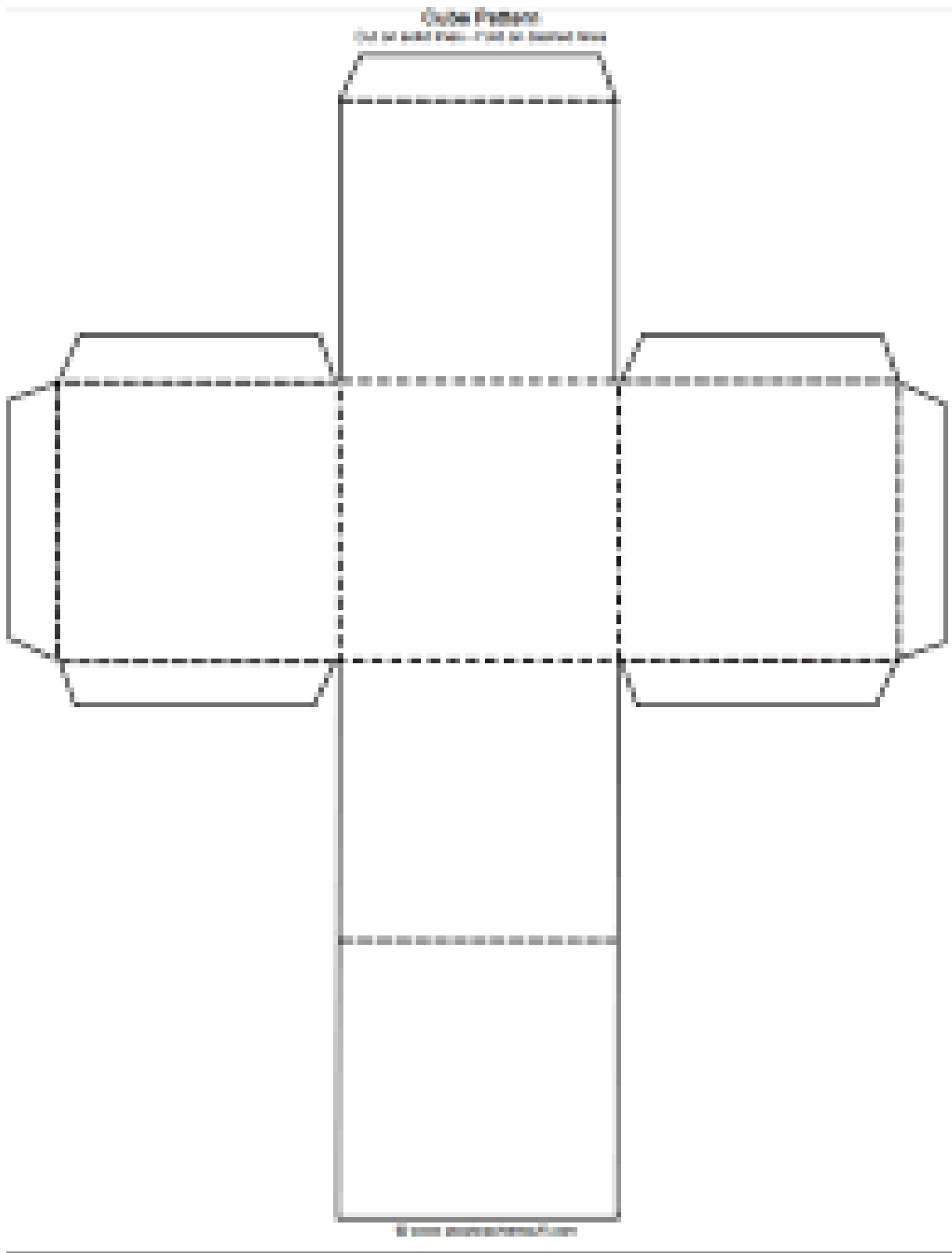

Use the net to create a cube, write the numbers 1-6 to turn your cube into a dice.